

H TECHNICAL PROCEDURE

PRECISION240® SPINDLE NUT SYSTEM

SUBJECT: Hubcap Compatibility
and Kit Information

LIT NO: T77002

DATE: July 2016

REVISION: B

ABOUT PRECISION240® NUT SYSTEM

This kit contains a patented PRECISION240® nut system: spindle nut (Figure 1), interlock washer and two washer retaining screws.

Hubcap compatibility is listed in the table on the following pages. For questions, contact Hendrickson Trailer Technical Services at 866-RIDEAIR (743-3247) or email HTTS@Hendrickson-intl.com.

RELATED LITERATURE

The table below includes a list of literature relative to PRECISION240 spindle nut applications.

NAME	DESCRIPTION
L583	<i>Comprehensive Warranty Statement</i>
T71005	<i>PRECISION320®, PRECISION240® Install Poster</i>
T72006	<i>HXL3® Wheel-end Maintenance Procedures</i>
T72007	<i>HXL5® Wheel-end Maintenance Procedures</i>

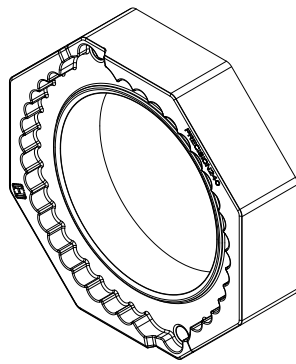

0.94" (23.88 mm) thick

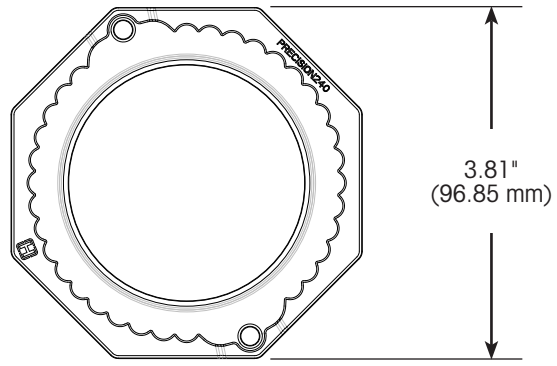







Powdered metal nut

Figure 1: PRECISION240® HN spindle nut system



PRECISION240® SPINDLE NUT COMPATIBILITY

This spindle nut is larger than some others offered by Hendrickson. If improper components are used, this could lead to interference between the hubcap and powdered metal nut system. It is therefore recommended to **use only genuine Hendrickson or Hendrickson approved replacement components**. Refer to the table below for a list of hubcaps that are compatible with the PRECISION240 powdered metal nut.

SPINDLE TYPE	HUB CAP BRAND	PICTURE	[H] P/N	MANUFACTURER P/N	TIRE INFLATION SYSTEM (TIS)	PRECISION240® NUT COMPATIBILITY?
HN ²	Hendrickson		A-28508	HS009P	None	No
			C-32049-1	N/A	TIREMAAX® PRO ¹	Yes
			C-32055-1	N/A	TIREMAAX PRO ¹	Yes
			C-32055-3	N/A	TIREMAAX PRO ¹	Yes
			C-32068-1	N/A	TIREMAAX CP Integrated ¹	Yes
			C-32068-3	N/A	TIREMAAX CP Integrated ¹	Yes
			C-33376	N/A	None	Yes







¹ For TIREMAAX® PRO and CP Integrated, allowance must be made for hubcap mounted rotary union. Refer to T57001 Wheel-end Considerations.

² The PRECISION240® nut system is designed for HN tapered spindles only.

³ Refer to L583 warranty coverage information when installing non-Hendrickson TIS on Hendrickson suspensions.



HUBCAP COMPATIBILITY AND KIT INFORMATION

SPINDLE TYPE	HUB CAP BRAND	PICTURE	[H] P/N	MANUFACTURER P/N	TIRE INFLATION SYSTEM (TIS)	PRECISION240® NUT COMPATIBILITY?
HN ²	Hendrickson		C-34784	N/A	None	Yes
			E32628-1	N/A	None	Yes
	Stemco		A-1974	343-4009	None	Yes
			A-23986	348-5307	None	Yes
			A-23987	349-4009	None	Yes
			C-31292	343-4307	TIREMAAX® EC & CP ³	Yes







¹ For TIREMAAX® PRO and CP Integrated, allowance must be made for hubcap mounted rotary union. Refer to T57001 *Wheel-end Considerations*.

² The PRECISION240® nut system is designed for HN tapered spindles only.

³ Refer to L583 warranty coverage information when installing non-Hendrickson TIS on Hendrickson suspensions.

HUBCAP COMPATIBILITY AND KIT INFORMATION



SPINDLE TYPE	HUB CAP BRAND	PICTURE	[H] P/N	MANUFACTURER P/N	TIRE INFLATION SYSTEM (TIS)	PRECISION240® NUT COMPATIBILITY?
HN ²	Dual Dynamics		N/A	201-GN	None	Yes
			C-26492	N/A	TIREMAAX® EC & CP ³	Yes
			C-26491	N/A	TIREMAAX EC & CP ³	Yes
			C-28572	207-PSN	None	Yes
			C-29467	202-G	None	Yes
			C-25885	106819	None	Yes
			C-25886	10018622	None	Yes









¹ For TIREMAAX® PRO and CP Integrated, allowance must be made for hubcap mounted rotary union. Refer to T57001 *Wheel-end Considerations*.

² The PRECISION240® nut system is designed for HN tapered spindles only.

³ Refer to L583 warranty coverage information when installing non-Hendrickson TIS on Hendrickson suspensions.

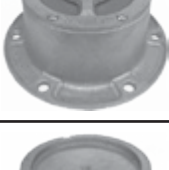

HUBCAP COMPATIBILITY AND KIT INFORMATION

SPINDLE TYPE	HUB CAP BRAND	PICTURE	[H] P/N	MANUFACTURER P/N	TIRE INFLATION SYSTEM (TIS)	PRECISION240® NUT COMPATIBILITY?
HN ²	Federal Mogul		N/A	343-009	None	No
			N/A	340-350	PSI ³	Yes
			N/A	HWB-009-4S	None	Yes
			N/A	HWG-609	None	Yes
			N/A	HWJ-609	None	Yes
			N/A	HWK-609	None	Yes
			N/A	HWM-650	PSI ³	Yes
			N/A	HWN-350	PSI ³	Yes
			N/A	HWQ-009-4	None	Yes

¹ For TIREMAAX® PRO and CP Integrated, allowance must be made for hubcap mounted rotary union. Refer to T57001 Wheel-end Considerations.
² The PRECISION240® nut system is designed for HN tapered spindles only.
³ Refer to L583 warranty coverage information when installing non-Hendrickson TIS on Hendrickson suspensions.



Call Hendrickson at **866.RIDEAIR (743.3247)** for additional information.



www.hendrickson-intl.com

TRAILER COMMERCIAL VEHICLE SYSTEMS

2070 Industrial Place SE
Canton, OH 44707-2641 USA
866.RIDEAIR (743.3247)
330.489.0045 • Fax 800.696.4416

Hendrickson Canada

250 Chrysler Drive, Unit #3
Brampton, ON Canada L6S 6B6
800.668.5360
905.789.1030 • Fax 905.789.1033

Hendrickson Mexicana

Circuito El Marqués Sur #29
Parque Industrial El Marqués
Pob. El Colorado, Municipio El Marqués,
Querétaro, México C.P. 76246
+52 (442) 296.3600 • Fax +52 (442) 296.3601